



**Oil Conserving Fryer (OCCF30)TM
Electric Series Fryers
Installation & Operation Manual**



Frymaster, a member of the Commercial Food Equipment Service Association, recommends using CFESA Certified Technicians.

24-Hour Service Hotline 1-800-551-8633

www.frymaster.com

E-mail: service@frymaster.com



NOTICE

IF, DURING THE WARRANTY PERIOD, THE CUSTOMER USES A PART FOR THIS MANITOWOC FOOD SERVICE EQUIPMENT OTHER THAN AN **UNMODIFIED** NEW OR RECYCLED PART PURCHASED DIRECTLY FROM FRYMASTER DEAN, OR ANY OF ITS FACTORY AUTHORIZED SERVICERS, AND/OR THE PART BEING USED IS MODIFIED FROM ITS ORIGINAL CONFIGURATION, THIS WARRANTY WILL BE VOID. FURTHER, FRYMASTER DEAN AND ITS AFFILIATES WILL NOT BE LIABLE FOR ANY CLAIMS, DAMAGES OR EXPENSES INCURRED BY THE CUSTOMER WHICH ARISE DIRECTLY OR INDIRECTLY, IN WHOLE OR IN PART, DUE TO THE INSTALLATION OF ANY MODIFIED PART AND/OR PART RECEIVED FROM AN UNAUTHORIZED SERVICER.

NOTICE

This appliance is intended for professional use only and is to be operated by qualified personnel only. A Frymaster Dean Factory Authorized Servicer (FAS) or other qualified professional should perform installation, maintenance, and repairs. Installation, maintenance, or repairs by unqualified personnel may void the manufacturer's warranty. See Chapter 1 of this manual for definitions of qualified personnel.

NOTICE

This equipment must be installed in accordance with the appropriate national and local codes of the country and/or region in which the appliance is installed. See **NATIONAL CODE REQUIREMENTS** in Chapter 2 of this manual for specifics.

NOTICE TO U.S. CUSTOMERS

This equipment is to be installed in compliance with the basic plumbing code of the Building Officials and Code Administrators International, Inc. (BOCA) and the Food Service Sanitation Manual of the U.S. Food and Drug Administration.

NOTICE

Drawings and photos used in this manual are intended to illustrate operational, cleaning and technical procedures and may not conform to onsite management operational procedures.

NOTICE TO OWNERS OF UNITS EQUIPPED WITH CONTROLLERS

U.S.

This device complies with Part 15 of the FCC rules. Operation is subject to the following two conditions: 1) This device may not cause harmful interference, and 2) This device must accept any interference received, including interference that may cause undesired operation. While this device is a verified Class A device, it has been shown to meet the Class B limits.

CANADA

This digital apparatus does not exceed the Class A or B limits for radio noise emissions as set out by the ICES-003 standard of the Canadian Department of Communications.

Cet appareil numérique n'émet pas de bruits radioélectriques dépassant les limites de classe A et B prescrites dans la norme NMB-003 édictée par le Ministre des Communications du Canada.

 DANGER

Improper installation, adjustment, maintenance or service, and unauthorized alterations or modifications can cause property damage, injury, or death. Read the installation, operating, and service instructions thoroughly before installing or servicing this equipment.

⚠ DANGER

The front ledge of this appliance is not a step! Do not stand on the appliance. Serious injury can result from slips or contact with the hot cooking oil.

⚠ DANGER

Do not store or use gasoline or other flammable liquids or vapors in the vicinity of this or any other appliance.

⚠ DANGER

The crumb tray in fryers equipped with a filter system must be emptied into a fireproof container at the end of frying operations each day. Some food particles can spontaneously combust if left soaking in certain shortening material.

⚠ WARNING

Do not bang fry baskets or other utensils on the fryer's joiner strip. The strip is present to seal the joint between the fry vessels. Banging fry baskets on the strip to dislodge shortening will distort the strip, adversely affecting its fit. It is designed for a tight fit and should only be removed for cleaning.

⚠ DANGER

Adequate means must be provided to limit the movement of this appliance without depending on or transmitting stress to the electrical conduit. A restraint kit is provided with the fryer. If the restraint kit is missing contact your local KES.

⚠ DANGER

Prior to movement, testing, maintenance and any repair on your Frymaster fryer, disconnect ALL electrical power from the fryer.

NOTICE

The instructions in this manual for using a bulk oil system for filling and discarding oil are for an RTI and Frontline system. These instructions may not be applicable to other bulk oil systems.

⚠ WARNING

This appliance is not intended for use by children under the age of 16 or persons with reduced physical, sensory or mental capabilities, or lack of experience and knowledge, unless they have been given supervision concerning use of the appliance by a person responsible for their safety. Do not allow children to play with this appliance.

⚠ WARNING

If the electrical power supply cord is damaged, it must be replaced by a Frymaster Factory Authorized Servicer or a similarly qualified person in order to avoid a hazard.



**OCF30™ Series Electric Fryers
Installation and Operation Manual**

TABLE OF CONTENTS

CHAPTER 1: Introduction

1.1 General 1-1
1.2 Safety Information 1-1
1.3 Computer Information..... 1-2
1.4 European Community (CE) Specific Information 1-2
1.5 Installation, Operating, and Service Personnel 1-2
1.6 Definitions..... 1-2
1.7 Shipping Damage Claim Procedure 1-3
1.8 Service Information..... 1-3

CHAPTER 2: Installation Instructions

2.1 General Installation Requirements 2-1
2.1.1 Clearance and Ventilation 2-2
2.1.2 Electrical Grounding Requirements 2-2
2.1.3 Australian Requirements 2-3
2.2 Power Requirements 2-3
2.3 Positioning the Fryer..... 2-4
2.4 Installing the JIB Cradle 2-4

CHAPTER 3: Operating Instructions

3.1 Equipment Setup and Start-Up Procedures 3-2
3.2 Operation..... 3-2
3.3 Oil Attendant™ Automatic Topoff..... 3-3
3.3.1 Install the Oil Reservoir 3-3
3.3.2 Routine Oil Changes 3-3
3.3.3 Bulk Oil Systems 3-4

CHAPTER 4: Filtration Instructions

4.1 Preparing the Built-In Filtration System for Use 4-1
4.1.1 Preparation for Use with Filter Paper or Filter Pad..... 4-1
4.1.2 Preparation for Use with Magnasol Filter Assembly 4-2
4.2 Filtration..... 4-3
4.2.1 Operation of the Filter 4-3
4.3 Disassembly and Reassembly of the Magnasol Filter 4-5
4.4 Draining and Disposing of Waster Oil..... 4-6

CHAPTER 5: Preventive Maintenance

5.1 Cleaning the Fryer..... 5-1
5.2 Daily Checks and Service 5-1
5.2.1 Inspect Fryer for Damage 5-1
5.2.2 Clean Fryer Cabinet Inside and Out..... 5-1
5.2.3 Clean the Built-in Filtration System 5-1
5.3 Weekly Checks and Service..... 5-2
5.3.1 Clean Frypot and Heating Elements 5-2
5.3.2 Boiling Out the Frypot 5-2
5.3.3 Clean Detachable Parts and Accessories..... 5-3

5.4	Monthly Checks and Service	5-3
5.4.1	Check Controller Setpoint Accuracy	5-3
5.5	Annual/Periodic System Inspection.....	5-3
5.5.1	Fryer.....	5-3
5.5.2	Built-In Filtration System	5-4

CHAPTER 6: Operator Troubleshooting

6.1	Introduction.....	6-1
6.2	Troubleshooting	6-2
6.2.1	Controller and Heating Problems	6-2
6.2.2	Error Message and Display Problems.....	6-2
6.2.3	Basket Lift Problems	6-3
6.2.4	Filtration Problems	6-4
6.2.5	Auto Top Off Problems	6-4
6.2.6	Error Log Codes.....	6-5
6.2.7	High Limit Test.....	6-5

Wiring Diagrams

See 8197224 OCF Electric Wiring Diagrams Manual

ADDENDUM A: Solid Shortening JIB Preparation Instructions

ADDENDUM B: Solid Shortening Melter Use Instructions

ADDENDUM C: Bulk Oil Instructions

OCF30™ SERIES ELECTRIC FRYERS

CHAPTER 1: INTRODUCTION

1.1 General

Read the instructions in this manual thoroughly before attempting to operate this equipment. This manual covers all configurations of FPEL14 and FPEL17 variants. The fryers in this model family have most parts in common, and when discussed as a group, will be referred to as “OCF30™ Series Electric” fryers.

Although similar in appearance to the RE Series Electric family of Electric fryers, the OCF30™ Series Electric fryers with SMART4U® technology feature a low oil volume frypot with an optional automatic oil top off system. The Euro-Look design incorporates a rounded topcap and a large round drain, which ensures that fries and other debris, will be washed into the filter pan. Other features, such as rotating elements and filtration system remain essentially unchanged. The OCF30™ Series Electric fryers are controlled with a 3000 or CM3.5 computer. Fryers in this series come in full- or split-vat arrangements, and can be purchased as two, three or four vat fryers.

1.2 Safety Information

Before attempting to operate your unit, read the instructions in this manual thoroughly.

Throughout this manual, you will find notations enclosed in double-bordered boxes similar to the one below.

 DANGER Hot cooking oil causes severe burns. Never attempt to move a fryer containing hot oil or to transfer hot oil from one container to another.

 **CAUTION** boxes contain information about actions or conditions that *may cause or result in a malfunction of your system.*

 **WARNING** boxes contain information about actions or conditions that *may cause or result in damage to your system,* and which may cause your system to malfunction.

 **DANGER** boxes contain information about actions or conditions that *may cause or result in injury to personnel,* and which may cause damage to your system and/or cause your system to malfunction.

The OCF30™ series electric fryers incorporate a high-temperature detection feature which shuts off power to the elements should the temperature controls fail.

1.3 Computer Information

This equipment has been tested and found to comply with the limits for a Class A digital device, pursuant to Part 15 of the FCC rules. While this device is a verified Class A device, it has been shown to meet the Class B limits. These limits are designed to provide reasonable protection against harmful interference when the equipment is operated in a commercial environment. This equipment generates, uses and can radiate radio frequency energy and, if not installed and used in accordance with the instruction manual, may cause harmful interference to radio communications. Operation of the equipment in a residential area is likely to cause harmful interference in which case the user will be required to correct the interference at their own expense.

The user is cautioned that any changes or modifications not expressly approved by the party responsible for compliance could void the user's authority to operate the equipment.

If necessary, the user should consult the dealer or an experienced radio and television technician for additional suggestions.

The user may find the following booklet prepared by the Federal Communications Commission helpful: "How to Identify and Resolve Radio-TV Interference Problems". This booklet is available from the U.S. Government Printing Office, Washington, DC 20402, Stock No. 004-000-00345-4.

1.4 European Community (CE) Specific Information

The European Community (CE) has established certain specific standards regarding equipment of this type. Whenever a difference exists between CE and non-CE standards, the information or instructions concerned are identified by means of shadowed boxes similar to the one below.

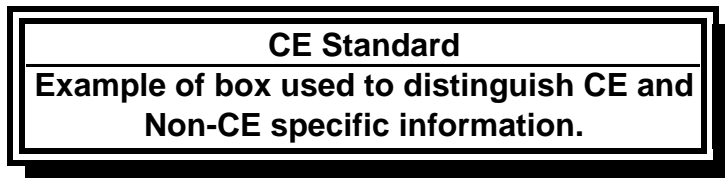

1.5 Installation, Operating, and Service Personnel

Operating information for Frymaster equipment has been prepared for use by qualified and/or authorized personnel only, as defined in Section 1.6. **All installation and service on Frymaster equipment must be performed by qualified, certified, licensed, and/or authorized installation or service personnel, as defined in Section 1.6.**

1.6 Definitions

QUALIFIED AND/OR AUTHORIZED OPERATING PERSONNEL

Qualified/authorized operating personnel are those who have carefully read the information in this manual and have familiarized themselves with the equipment functions, or who have had previous experience with the operation of the equipment covered in this manual.

QUALIFIED INSTALLATION PERSONNEL

Qualified installation personnel are individuals, firms, corporations, and/or companies which, either in person or through a representative, are engaged in and are responsible for the installation of electrical appliances. Qualified personnel must be experienced in such work, be familiar with all electrical precautions involved, and have complied with all requirements of applicable national and local codes.

QUALIFIED SERVICE PERSONNEL

Qualified service personnel are those who are familiar with Frymaster equipment and who have been authorized by Frymaster, L.L.C. to perform service on the equipment. All authorized service personnel are required to be equipped with a complete set of service and parts manuals, and to stock a minimum amount of parts for Frymaster equipment. A list of Frymaster Factory Authorized Servicemen (FAS's) is located on the Frymaster website at www.frymaster.com/service. ***Failure to use qualified service personnel will void the Frymaster warranty on your equipment.***

1.7 Shipping Damage Claim Procedure

What to do if your equipment arrives damaged:

Please note that this equipment was carefully inspected and packed by skilled personnel before leaving the factory. **Frymaster does not assume responsibility for damage or loss incurred in transit.** The freight company assumes full responsibility for safe delivery upon acceptance of the equipment.

1. File Claim for Damages Immediately—Regardless of extent of damage.
2. Visible Loss or Damage—Be sure this is noted on the freight bill or express receipt and is signed by the person making the delivery.
3. Concealed Loss or Damage—If damage is unnoticed until equipment is unpacked, notify the freight company or carrier immediately and file a concealed damage claim. This should be done within 15 days of date of delivery. Be sure to retain container for inspection.

1.8 Service Information

For non-routine maintenance or repairs, or for service information, contact your local Frymaster Factory Authorized Serviceman (FAS). Service information may also be obtained by calling the Frymaster Technical Services Department at 1-800-551-8633 or 1-318-865-1711 or by e-mail at service@frymaster.com. The following information will be needed in order to assist you efficiently:

Model Number _____

Serial Number _____

Voltage _____

Nature of the Problem _____

RETAIN AND STORE THIS MANUAL IN A SAFE PLACE FOR FUTURE USE.

OCF30™ SERIES ELECTRIC FRYERS

CHAPTER 2: INSTALLATION INSTRUCTIONS

2.1 General Installation Requirements

Proper installation is essential for the safe, efficient, trouble-free operation of this appliance.

Qualified, licensed, and/or authorized installation or service personnel, as defined in Section 1.6 of this manual, should perform all installation and service on Frymaster equipment.

Failure to use qualified, licensed, and/or authorized installation or service personnel (as defined in Section 1.6 of this manual) to install or otherwise service this equipment will void the Frymaster warranty and may result in damage to the equipment or injury to personnel.

Where conflicts exist between instructions and information in this manual and local or national codes or regulations, installation and operation shall comply with the codes or regulations in force in the country in which the equipment is installed.

Service may be obtained by contacting your local Frymaster Factory Authorized Servicer.

NOTICE

All fryers shipped without factory supplied cords and plug assemblies must be hardwired using flexible conduit to the terminal block located on the rear of the fryer. These fryers should be wired to NEC specifications. Hardwired units must include installation of restraint devices.

DANGER

Adequate means must be provided to limit the movement of this appliance without depending on or transmitting stress to the electrical conduit. A restraint kit is provided with the fryer. If the restraint kit is missing contact your local KES.

NOTICE

If this equipment is wired directly into the electrical power supply, a means for disconnection from the supply having a contact separation of at least 3-mm in all poles must be incorporated in the fixed wiring.

NOTICE

This equipment must be positioned so that the plug is accessible unless other means for disconnection from the power supply (e.g., a circuit breaker) is provided.

NOTICE

If this appliance is permanently connected to fixed wiring, it must be connected by means of copper wires having a temperature rating of not less than 167°F (75°C).

NOTICE

If the electrical power supply cord is damaged, it must be replaced by a Frymaster Dean Factory Authorized Service technician or a similarly qualified person in order to avoid a hazard.

⚠ DANGER

This appliance must be connected to a power supply having the same voltage and phase as specified on the rating plate located on the inside of the appliance door.

⚠ DANGER

All wiring connections for this appliance must be made in accordance with the wiring diagram(s) furnished with the appliance. Refer to the wiring diagram(s) affixed to the inside of the appliance door when installing or servicing this equipment.

⚠ DANGER

Frymaster appliances equipped with legs are for stationary installations. Appliances fitted with legs must be lifted during movement to avoid damage to the appliance and bodily injury. For movable installations, optional equipment casters must be used. Questions? Call 1-800-551-8633.

⚠ DANGER

Do not attach an apron drainboard to a fryer. The fryer may become unstable, tip over and cause injury. The appliance area must be kept free and clear of combustible material at all times.

⚠ DANGER

Building codes prohibit a fryer with its open tank of hot oil being installed beside an open flame of any type, including those of broilers and ranges.

In the event of a power failure, the fryer(s) will automatically shut down. If this occurs, turn the power switch OFF. Do not attempt to start the fryer(s) until power is restored.

2.1.1 Clearance and Ventilation

This appliance must be kept free and clear of combustible material, except that it may be installed on combustible floors.

A clearance of 6 inches (15cm) must be provided at both sides and back adjacent to combustible construction. A minimum of 24 inches (61cm) should be provided at the front of the equipment for servicing and proper operation.

⚠ WARNING

Do not block the area around the base or under the fryers.

2.1.2 Electrical Grounding Requirements

All electrically operated appliances must be grounded in accordance with all applicable national and local codes, and, where applicable, CE codes. All units (cord connected or permanently connected) should be connected to a grounded power supply system. A wiring diagram is located on the inside of the fryer door. Refer to the rating plate on the inside of the fryer door for proper voltages.

2.1.3 Australian Requirements

To be installed in accordance with AS 5601, local authority, gas, electricity, and any other relevant statutory regulations.

2.2 Power Requirements

Three (3) Phase Requirements				
MODEL	VOLTAGE	WIRE SERVICE	MINIMUM WIRE SIZE AWG (mm)	AMPS (per leg)
FPEL14	208	3	6 (4.11)	39
FPEL14	240	3	6 (4.11)	34
FPEL14	480	3	8 (2.59)	17
FPEL14	220/380	4	6 (4.11)	21
FPEL14	240/415	4	6 (4.11)	20
FPEL14	230/400	4	6 (4.11)	21
FPEL17	208	3	6 (4.11)	48
FPEL17	240	3	6 (4.11)	41
FPEL17	480	3	6 (4.11)	21
FPEL17	220/380	4	6 (4.11)	26
FPEL17	240/415	4	6 (4.11)	24
FPEL17	230/400	4	6 (4.11)	25

NOTICE

If this appliance is permanently connected to fixed wiring, it must be connected by means of copper wires having a temperature rating of not less than 167°F (75°C).

DANGER

This appliance must be connected to a power supply having the same voltage and phase as specified on the rating plate located on the inside of the appliance door.

DANGER

All wiring connections for this appliance must be made in accordance with the wiring diagram(s) furnished with the appliance. Refer to the wiring diagram(s) affixed to the inside of the appliance door when installing or servicing this equipment.

2.3 Positioning the Fryer

⚠ DANGER

No structural material on the fryer should be altered or removed to accommodate placement of the fryer under a hood. Questions? Call the Frymaster Dean Service Hotline at 1-800-551-8633.

1. Once the fryer has been positioned at the frying station, use a carpenter's level placed across the top of the frypot to verify that the unit is level, both side-to-side and front-to-back.

To level fryers, adjust the casters being careful to ensure the fryer(s) are at the proper height in the frying station.

When the fryer is leveled in its final position, install the restraints provided by the KES to limit its movement so that it does not depend on or transmit stress to the electrical conduit or connection. Install the restraints in accordance with the provided instructions. If the restraints are disconnected for service or other reasons, they must be reconnected before the fryer is used.

⚠ DANGER

Adequate means must be provided to limit the movement of this appliance without depending on or transmitting stress to the electrical conduit. A restraint kit is provided with the fryer. If the restraint kit is missing contact your local KES.

⚠ DANGER

Hot oil can cause severe burns. Avoid contact. Under all circumstances, oil must be removed from the fryer before attempting to move it to avoid oil spills, falls and severe burns. This fryer may tip and cause personal injury if not secured in a stationary position.

2. Close fryer drain-valve(s).
3. Clean and fill frypot(s) to the bottom oil level line with cooking oil. (See *Equipment Setup and Shutdown Procedures* in Chapter 3.)

2.4 Installing the JIB Cradle

Open the fryer door (typically the far right door) and remove the cross brace used for shipping support by removing the four screws (see Figure 1). Install the JIB cradle shipped in the accessories pack with the screws that were removed in the cross brace removal step (see Figure 2). If using the solid shortening option see Appendix A in the rear of this manual for installation instructions. Install the optional JIB splash shield to protect the bottom of the JIB (see Figure 3).

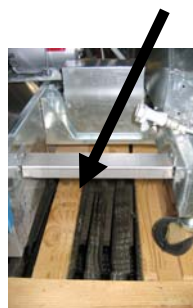

Figure 1

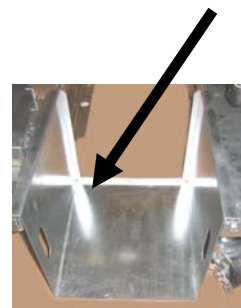

Figure 2

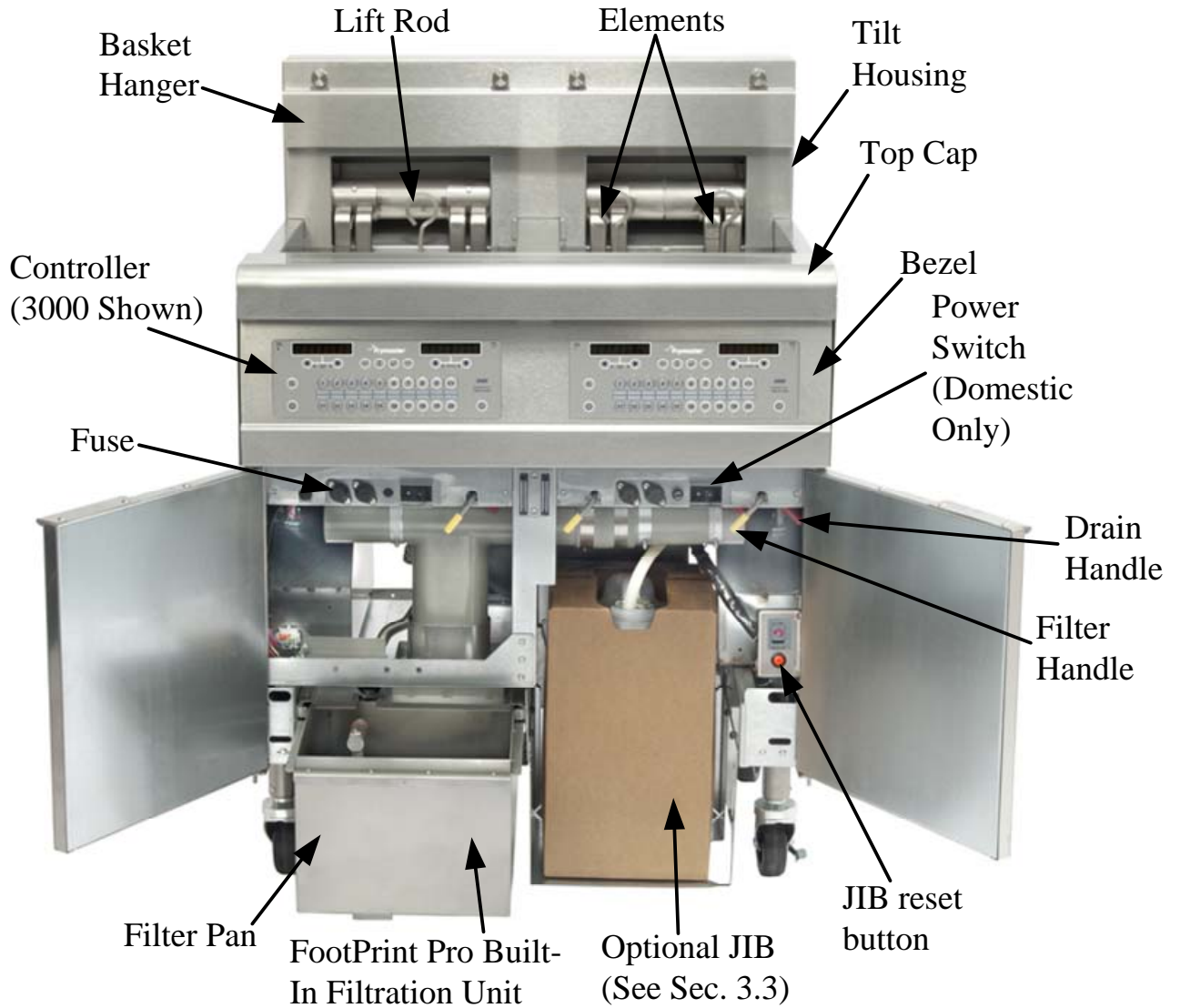

Figure 3

OCF30™ SERIES ELECTRIC FRYER

CHAPTER 3: OPERATING INSTRUCTIONS

FINDING YOUR WAY AROUND THE OCF30™ SERIES ELECTRIC FRYER



TYPICAL CONFIGURATION (FPEL214 SHOWN)

NOTE: The appearance of your fryer may differ slightly from that shown depending upon the configuration and date of manufacture.

3.1 Equipment Setup and Shutdown Procedures

Setup

 **DANGER**

Never operate the appliance with an empty frypot. The frypot must be filled to the fill line with water or oil before energizing the elements. Failure to do so will result in irreparable damage to the elements and may cause a fire.

 **DANGER**

Remove all drops of water from the frypot before filling with oil. Failure to do so will cause spattering of hot liquid when the oil is heated to cooking temperature.

 **WARNING**

The OCF30™ with the automatic top off is **NOT** intended to use solid shortening. Use only liquid shortening with this fryer. The use of solid shortening will clog the oil lines. The cooking oil capacity of the OCF30™ Series electric fryer is 31 lbs. (3.7 gallons/14 liters) at 70°F (21°C).

 **DANGER**

When using solid shortening, pack the shortening down into the bottom of the frypot. **DO NOT** operate the fryer with a solid block of shortening sitting in the upper portion of the frypot. This will cause damage to the frypot and may cause a flash fire.

Prior to filling frypots with oil ensure all drains are closed.

1. Fill the frypot with cooking oil to the bottom OIL LEVEL line located on the rear of the frypot. This will allow for oil expansion as heat is applied. Do not fill cold oil any higher than the bottom line; overflow may occur as heat expands the oil.
2. Ensure that the power cord(s) is/are plugged into the appropriate receptacle(s). Verify that the face of the plug is flush with the outlet plate, with no portion of the prongs visible.
3. Ensure that the power is switched on. Some models are equipped with a master switch located behind the fryer door cabinet on the front panel of the component box, next to the fuse. **OFF** is displayed on the controller.
4. Ensure that the controller is switched ON. When the controller is switched on, the fryer will begin heating and will display **MELT-CYCL** alternating with the temperature and setpoint until the fryer temperature reaches 180°F (82°C). On CM 3.5 equipped fryers the display changes to **LOW TEMP** until within 15°F of the setpoint. Then the display changes to product or dashed lines. On the 3000, once the fryer reaches setpoint, the controller display changes to **DROP** and the fryer is ready for use. To exit the melt cycle on the 3000, press the EXIT COOL button. Press YES to EXIT MELT?
5. Ensure that the oil level is at the *top* OIL LEVEL line when the oil *is at its cooking temperature*.

Shutdown

1. Filter the oil and clean the fryers (See Chapters 5 and 6). If using a CM3.5 reverse steps 1 and 2.
2. Turn the fryer off.
3. Place the frypot covers on the frypots.

3.2 Operation

This fryer is equipped with either 3000 or CM3.5 controllers (illustrated on the following page). Fryers with 3000 controllers should refer to the *3000 Controller Manual 819-6872* for the controller programming and operating procedure. For CM3.5 controllers refer to the separate *Frymaster Fryer Controllers User's Manual* furnished with your fryer for the specific controller operating instructions.



3000 CONTROLLER

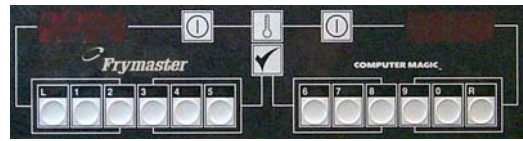

CM3.5

Refer to Chapter 4 of this manual for operating instructions for the built-in filtration system.

3.3 Optional Oil Attendant® Automatic Top-Off

When the Oil Attendant® top-off oil system is in place on the fryer, oil is continually topped off in the frypots from a reservoir in the cabinet. The reservoir holds a 35 pound box of oil. In a typical operation this will last approximately two days before changing. Components of the system are annotated at the right (see Figure 1).

NOTE: The system is intended to top off the frypots, not fill them. The frypots will require manual filling upon startup and after disposal.

Special Cap: Has plumbing attached to draw oil from the reservoir to the fryer vats.

Jug In Box (JIB): The JIB is the reservoir for the oil.

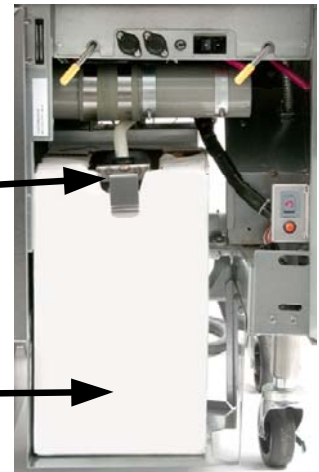

Figure 1

3.3.1 Install the Oil Reservoir

Remove the original lid from the oil container and foil liner. Replace with the provided cap, which has connected suction hardware. Ensure the feeder tube from the cap reaches to the bottom of the oil container.

Place the oil container inside the cabinet and slide it into place (as shown on the following page). Avoid catching the suction hardware on the cabinet interior as the container is placed in the fryer.

The system is now ready for operation. As the fryer heats to preprogrammed temperatures, the system will energize and then slowly add oil to the frypots as needed, until the oil reaches an optimal level.

3.3.2 Routine Oil Changes

When the oil reservoir level is low, the controller displays **TOPOFF OIL EMPTY** in the left display and **CONFIRM** in the right display. Press **▲** (CONFIRM). Some procedures may differ from photos shown. Follow manufacturer's instructions for changing the JIB. If using solid shortening see Appendix B in the rear of this manual for instructions.

1. Open the cabinet and slide the JIB from the cabinet (see Figure 4).
2. Remove the cap and pour any remaining oil in the container into all fry vats equally (see Figure 5).



Figure 4



Figure 5

3. With the jug upright remove the cap and foil seal (see Figure 6).
4. Put the tube in the new full container (see Figure 7).



Figure 6



Figure 7

WARNING:
Do not add **HOT** or
USED oil to a JIB.

5. Slide the JIB onto the shelf inside the fryer cabinet (as seen in Figure 4).
6. Press and hold the orange JIB reset switch **three (3) seconds** to reset the top off system (see Figure 8).

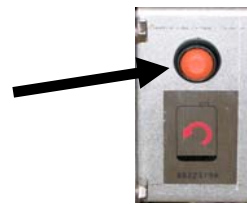

Figure 8

Image and location may differ from photo.

3.3.3 Bulk Oil Systems

Instructions for installing and using bulk oil systems are found in Appendix C located at the rear of this manual.

OCF30™ SERIES ELECTRIC FRYERS

CHAPTER 4: FILTRATION INSTRUCTIONS

WARNING

The on-site supervisor is responsible for ensuring that operators are made aware of the inherent hazards of operating a hot oil filtering system, particularly the aspects of oil filtration, draining and cleaning procedures.

4.1 Preparing the Built-In Filtration System for Use

The FootPrint Pro filtration system allows the oil in one frypot to be safely and efficiently filtered while the other frypots in a battery remain in operation. The FootPrint Pro filtration system is available in three different configurations:

- Filter Paper – includes crumb tray, large hold-down ring, and metal filter screen.
- Filter Pad – includes crumb tray, small hold-down ring, and metal filter screen.
- Magnasol Filter – includes crumb tray and Magnasol filter assembly.

Section 4.1.1 covers preparation of the Filter Paper and Filter Pad configurations for use. Refer to Section 4.1.2 for instructions on preparing the Magnasol Filter configuration for use. Operation of all three configurations is the same and is covered in section 4.3. Disassembly and reassembly of the Magnasol filter is covered in section 4.4.

4.1.1 Preparing the Built-In Filtration System for Use with Filter Paper or Filter Pad

The FootPrint Pro filtration system allows the oil in one frypot to be safely and efficiently filtered while the other frypots in a battery remain in operation. The FootPrint Pro filtration system uses a filter paper configuration which includes a crumb tray, large hold-down ring, and metal filter screen.

1. Pull the filter pan out from the cabinet and remove the crumb tray, hold-down ring, filter paper and filter screen (see Figure 1). Clean all components with a solution of detergent and hot water then dry thoroughly.

The pan cover must not be removed except for cleaning, interior access, or to allow a shortening disposal unit (SDU) built before January 2004 to be positioned under the drain. Disposal instructions are on page 1-6 in the controller manual 819-6872.

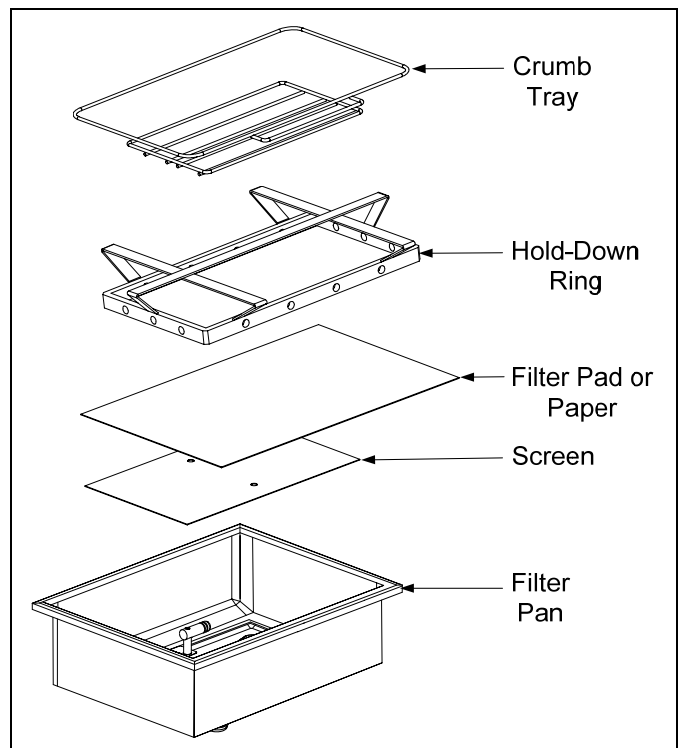

Figure 1

2. Inspect the filter pan connection fitting to ensure that both O-rings are in good condition (see Figure 2).
3. Then in reverse order, place the metal filter screen in the center of the bottom of the pan, then lay a sheet of filter paper on top of the screen, overlapping on all sides (see Figure1). If using a filter pad, ensure the rough side of the pad is up and lay the pad over the screen, making sure that the pad is in between the embossed ridges of the filter pan.
4. Position the hold-down ring over the filter paper and lower the ring into the pan, allowing the paper to rest on the sides of the filter pan (see Figure 3).
5. When the hold-down ring is in position, if using filter paper, sprinkle one packet of filter powder evenly over the paper. (See Figure 4)
6. Replace the crumb tray in the filter pan, then push the filter pan back into the fryer, positioning it under the drain.

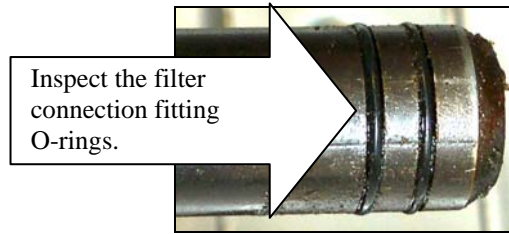

Figure 2



Figure 3



Figure 4

4.1.2 Preparation for Use with the Magnasol Filter Assembly

1. Pull the filter pan out from the cabinet and remove the crumb tray and Magnasol filter assembly (see Figure 5). Clean as directed in section 4.4

The pan cover must not be removed except for cleaning, interior access, or to allow a shortening disposal unit (SDU) to be positioned under the drain.

NOTE: Refer to Section 4.4 for instructions on how to disassemble and reassemble the Magnasol filter screen assembly.

2. Inspect the fitting on the bottom of the Magnasol filter assembly to ensure that the O-ring is present and in good condition. (See Figure 6)
3. Inspect the filter pan connection fitting to ensure that both O-rings are present and in good condition. (See Figure 2 above).
4. Replace the Magnasol filter assembly in the filter pan, ensuring that the fitting on the bottom of the assembly is securely

seated in the port in the bottom of the pan. Sprinkle one packet of the Magnasol XL filter powder evenly over the screen.

5. Replace the crumb tray, and then push the filter pan back into the fryer, positioning it all the way to the back of the cabinet.



Figure 5

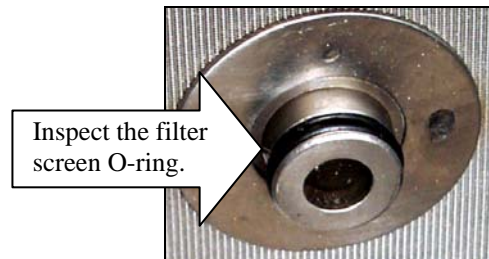

Figure 6

4.2 Filtration

A 3000 controller prompts the user when to filter on the OCF30™ fryer. After a preset number of cook cycles the controller displays **FILTER NOW?** alternating with **YES NO**. Follow the instructions on page 1-12 of the 3000 controller manual (819-6872). If NO is selected or a cook cycle is started, the controller will prompt again soon to filter the oil.

On demand filtration is used to manually start a filter. See page 1-11 of the 3000 controller manual (819-6872) for the filter menu.

The fryer **MUST** be at setpoint temperature for any filtration operation to start.

Note: Do NOT filter multiple vats simultaneously.

4.2.1 Operation of the Filter

⚠ DANGER

Draining and filtering of cooking oil must be accomplished with care to avoid the possibility of a serious burn caused by careless handling. The oil to be filtered is at or near 350°F (177°C). Ensure drain handles are in their proper position before operating any switches or valves. Wear all appropriate safety equipment when draining and filtering cooking oil.

⚠ DANGER

NEVER attempt to drain cooking oil from the fryer with the elements energized! Doing so will cause irreparable damage to the frypot and may cause a flash fire. Doing so will also void the Frymaster warranty.

1. Ensure that the filter is prepared. See Section. 4.1.
2. Make sure the oil is at operating temperature.
3. When prompted, drain the frypot into the filter pan by rotating the drain valve handle 90° (see Figure 7). If necessary, use the *Fryer's Friend* clean-out rod to clear the drain from **inside** the frypot.

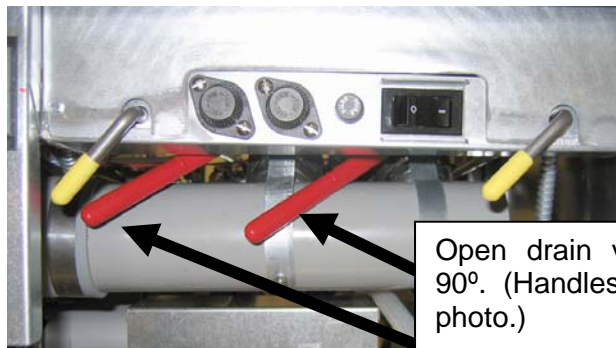

Figure 7

⚠ DANGER

Do not drain more than one frypot at a time into the built-in filtration unit to avoid overflow and spillage of hot oil that may cause severe burns, slipping and falling.

⚠ DANGER

NEVER attempt to clear a clogged drain valve from the front of the valve! Hot oil will rush out creating the potential for severe burns.

⚠ DANGER

DO NOT hammer on the drain valve with the cleanout rod or other objects. Damage to the ball inside will result in leaks and will void the Frymaster warranty.

4. After the oil has drained from the frypot and when prompted, rotate the filter handle towards the “I” to start the pump and begin the filtering process. There may be a slight delay before the pump activates (see Figure 8).

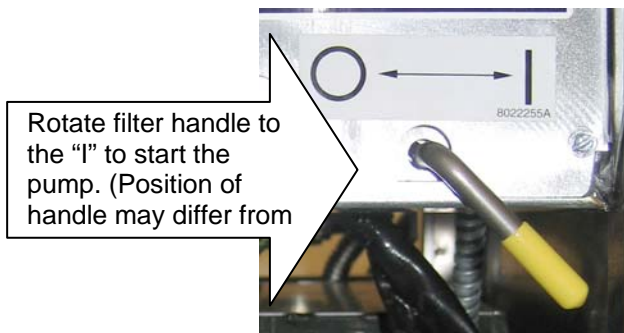

Figure 8

5. The filter pump draws the oil through the filter medium and circulates it back up to and through the frypot during a filter.
6. After the oil is filtered, close the drain valve when prompted and allow the fryer to refill. Let the filter pump run 10 to 12 seconds after the oil begins to bubble. Turn the filter off.
7. Ensure the drain valve is fully closed. (If the drain valve is not fully closed, the fryer will not operate.)
8. Turn the filter off when prompted.

The computer displays **OFF** when finished.

⚠ WARNING

The filter pump is equipped with a manual reset switch in case the filter motor overheats or an electrical fault occurs. If this switch trips, turn off power to the filter system and allow the pump motor to cool 20 minutes before attempting to reset the switch (see photo below).

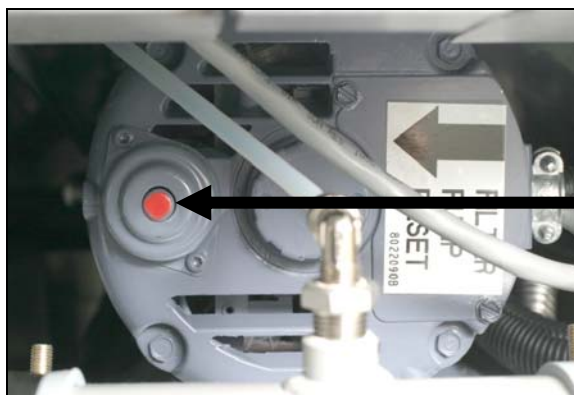

Filter Pump Reset Switch

⚠ WARNING

Use caution and wear appropriate safety equipment when resetting the filter pump reset switch. Resetting the switch must be accomplished with care to avoid the possibility of a serious burn caused by careless maneuvering around a drain tube and around a frypot.

⚠ DANGER

The crumb tray in fryers equipped with a filter system must be emptied into a fireproof container at the end of frying operations each day. Some food particles can spontaneously combust if left soaking in certain shortening material.

⚠ WARNING

Do not bang fry baskets or other utensils on the fryer's joiner strip. The strip is present to seal the joint between the fry vessels. Banging fry baskets on the strip to dislodge shortening will distort the strip, adversely affecting its fit. It is designed for a tight fit and should only be removed for cleaning.

4.3 Disassembly and Reassembly of the Magnasol Filter

Disassembly

1. Grasp the frame with your thumbs on the handles at the corner of the assembly and pull outward in opposite directions to separate the frame at the corner. Continue to open the frame (it will pivot at the opposite corner) until the outer screens and grid can be removed from the frame.

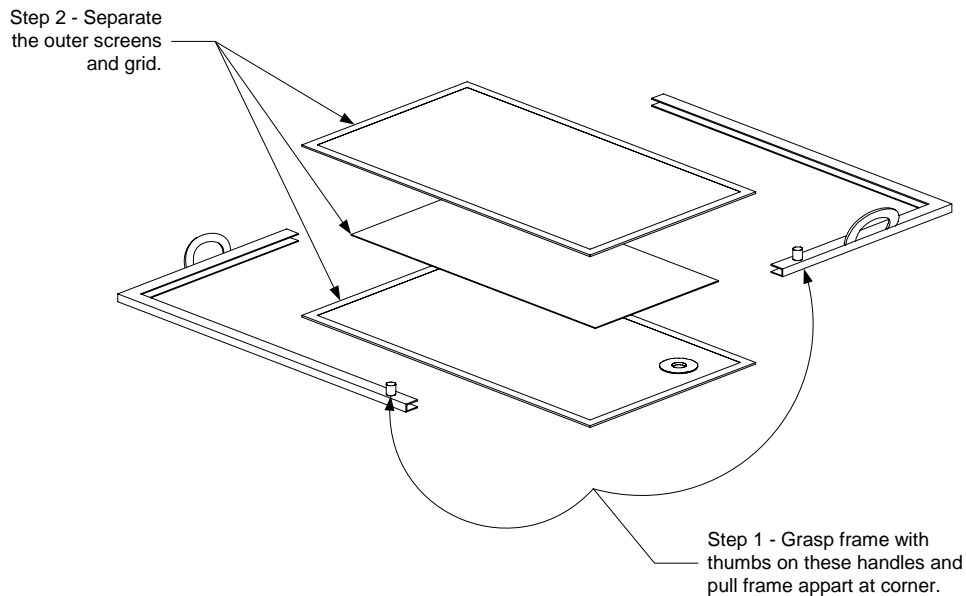

2. Separate the outer screens and grid.

Cleaning

1. Clean the two frame pieces, outer screens, and grid using a good quality degreaser and hot water from a spray nozzle. The groove in the seal frame pieces can be cleaned with the edge of a Scotch-Brite™ or similar cleaning pad.

2. At each scheduled boil-out, disassemble the leaf filter assembly and place in the frypot being boiled out. Follow the boil-out procedure in Section 5.3.2 of this manual.
3. Allow all filter assembly components to air dry or thoroughly dry with clean towels before reassembling.

Reassembly

1. Place the two outer screens together and align their edges (see illustration below).
2. Insert the screens into one of the frame halves (it doesn't matter which one). Ensure that the fitting in the bottom screen is on the opposite side of the frame from the handle.
3. Slip the grid between the screens, ensuring that the grid is centered between the edges of the screens.
4. Connect the other half of the frame at the corner opposite the handles and pivot the frame onto the free edges of the screen.

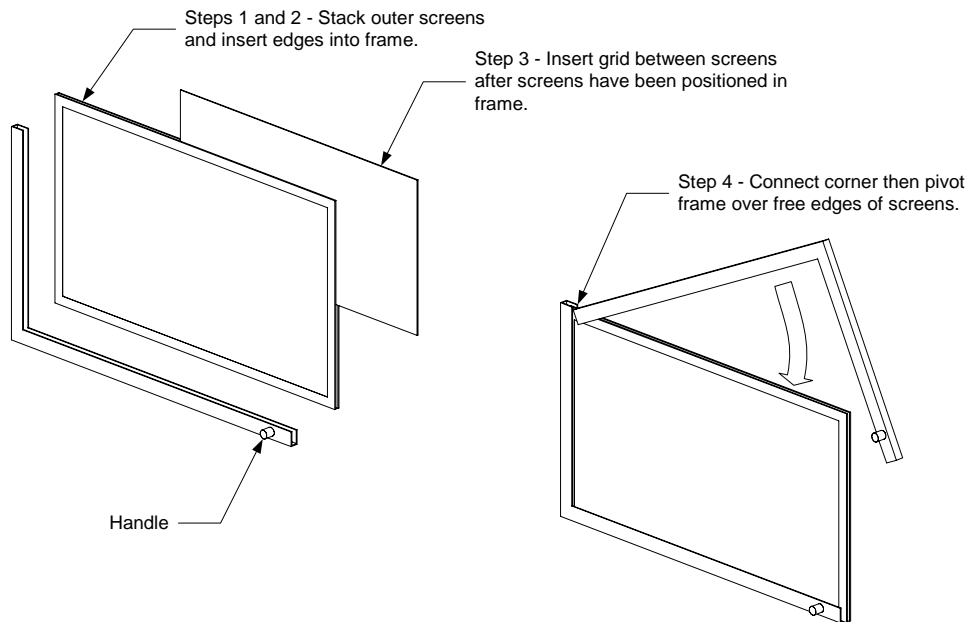

4.4 Draining and Disposing of Waste Oil

When cooking oil is exhausted, the oil must be drained into the filter pan, SDU or other appropriate METAL container for transport to the disposal container or if a bulk oil system is installed, use the bulk oil disposal system by selecting **DISPOSE** from the filter menu if the fryer is equipped with a 3000 (see page 1-13 of the 3000 controller manual 819-6872.) and follow the prompts and instructions for disposing oil to the bulk oil system. (For safe, convenient draining and disposal of used oil, Frymaster recommends the use of the Frymaster Shortening Disposal Unit (SDU) for JIB systems. The SDU is available through your local distributor.) **NOTE:** If using an SDU built before January 2004 the filter pan cover must be removed to allow the unit to be positioned beneath the drain. To remove the lid, lift up on the front edge and pull it straight out of the cabinet. Refer to the documentation furnished with your disposal unit for specific operating instructions. If a shortening

disposal unit is not available, allow the oil to cool to 100°F (38°C), then drain the oil into a METAL stockpot or similar METAL container.

⚠ DANGER

Draining and filtering of cooking oil must be accomplished with care to avoid the possibility of a serious burn caused by careless handling. The oil to be filtered is at or near 350°F (177°C). Ensure all hoses are connected properly and drain handles are in their proper position before operating any switches or valves. Wear all appropriate safety equipment when draining and filtering oil.

⚠ DANGER

Allow oil to cool to 100°F (38°C) before draining into an appropriate METAL container for disposal.

⚠ DANGER

When draining oil into a disposal unit, do not fill above the maximum fill line located on the container.

1. Turn the computer power switch to the **OFF** position.
2. Position a METAL container with a sealable cover under the drainpipe. The METAL container must be able to withstand the heat of the oil and hold hot liquids.
3. Follow the instructions for disposing of oil on page 1-13 of the 3000 controller manual 819-6872 if equipped with a 3000. Open the drain valve slowly to avoid splattering. If the drain valve becomes clogged with food particles, use the Fryer's Friend (poker-like tool) to clear the blockage.

⚠ DANGER

NEVER attempt to clear a clogged drain valve from the front of the valve! Hot oil will rush out creating the potential for severe burns.

⚠ DANGER

DO NOT hammer on the drain valve with the cleanout rod or other objects. Damage to the ball inside will result in leaks and will void the Frymaster warranty.

4. After draining the oil, clean all food particles and residual oil from the frypot. BE CAREFUL, this material may still cause severe burns if it comes in contact with bare skin.
5. Ensure the drain valve is closed securely and fill the frypot with clean, filtered or fresh cooking oil to the bottom OIL-LEVEL line.

OCF30™ SERIES ELECTRIC FRYERS

CHAPTER 5: PREVENTATIVE MAINTENANCE

5.1 Cleaning the Fryer

 **DANGER**

The crumb tray in fryers equipped with a filter system must be emptied into a fireproof container at the end of frying operations each day. Some food particles can spontaneously combust if left soaking in certain shortening material.

 **DANGER**

Never attempt to clean the fryer during the frying process or when the frypot is filled with hot oil. If water comes in contact with oil heated to frying temperature, it will cause spattering of the oil, which can result in severe burns to nearby personnel.

 **WARNING**

Use a commercial-grade cleaner formulated to effectively clean and sanitize food-contact surfaces. Read the directions for use and precautionary statements before use. Particular attention must be paid to the concentration of cleaner and the length of time the cleaner remains on the food-contact surfaces.

5.2 DAILY CHECKS AND SERVICE

5.2.1 Inspect Fryer and Accessories for Damage- Daily

Look for loose or frayed wires and cords, leaks, foreign material in frypot or inside cabinet, and any other indications that the fryer and accessories are not ready and safe for operation.

5.2.2 Clean Inside and Outside of the Fryer Cabinet – Daily

Clean inside the fryer cabinet with a dry, clean cloth. Wipe all accessible metal surfaces and components to remove accumulated oil and dust.

Clean outside the fryer cabinet with a clean, damp cloth soaked with detergent. Wipe with a clean, damp cloth.

5.2.3 Clean the Built-in Filtration System Daily

 **WARNING**

Never operate the filter system without oil in the system.

 **WARNING**

Never use the filter pan to transport old oil to the disposal area.

 **WARNING**

Never drain water into the filter pan. Water will damage the filter pump.

There are no periodic preventive maintenance checks and services required for your FootPrint Pro Filtration System other than daily cleaning of the filter pan and associated components with a solution of hot water and detergent.

If you notice that the system is pumping slowly or not at all, verify that the filter pan screen is on the bottom of the filter pan, with the paper on top of the screen. (If the unit is equipped with a Magnasol filter screen rather than with the standard screen and paper system, verify that the O-ring on the bottom fitting of the screen is present and in good condition.) Verify that the two O-ring(s) on the fitting at the right front of the filter pan are present and in good condition.

5.3 WEEKLY CHECKS AND SERVICE

5.3.1 Clean Frypot and Heating Elements

 **DANGER**

Never operate the appliance with an empty frypot. The frypot must be filled to the fill line with water or oil before energizing the elements. Failure to do so will result in irreparable damage to the elements and may cause a fire.

5.3.2 Boiling Out the Frypot

After the fryer has been in use for a period of time, a hard film of caramelized oil will form on the inside of the frypot. This film should be periodically removed by following the boil out procedure that follows.

1. Before switching the fryer(s) ON, close the frypot drain valve(s), then fill the empty frypot with a mixture of cold water and detergent. Follow instructions on detergent container when mixing.
2. For fryers equipped with 3000 controllers, program the controller for boil-out as described on page 1-15 of the GM3000 Controller Manual. For fryers equipped with CM 3.5 controllers, program the controller for boil-out as described in the separate Frymaster Fryer Controllers User's Manual.
3. Simmer the solution for 30 minutes to one hour. Do not allow the water level to drop below the bottom oil-level line in the frypot during the boil-out operation.

 **DANGER**

Never leave the fryer unattended during the boil-out process. If the boil-out solution boils over, turn the fryer off immediately and let the solution cool for a few minutes before resuming the process.

4. Turn the fryer ON/OFF switch(s) to the OFF position.
5. Add two gallons (7.6 liters) of water. Drain out the solution and clean the frypot(s) thoroughly.

 **WARNING**

Do not drain boil-out solution into a shortening disposal unit (SDU), a built-in filtration unit, or a portable filter unit. These units are not intended for this purpose, and will be damaged by the solution.

6. Refill the frypot(s) with clean water. Rinse the frypot(s) twice, drain and dry with a clean towel. Thoroughly remove all water from the frypot and elements before refilling the frypot with oil.

⚠ DANGER

Remove all drops of water from the frypot before filling with oil. Failure to do so will cause spattering of hot liquid when the oil is heated to cooking temperature.

5.3.3 Clean Detachable Parts and Accessories – Weekly

Wipe all detachable parts and accessories with a clean, dry cloth. Use a clean cloth saturated with detergent to remove accumulated carbonized oil on detachable parts and accessories. Rinse the parts and accessories thoroughly with clean water and wipe dry before reinstalling.

5.4 MONTHLY CHECKS AND SERVICE

5.4.1 Check the Controller Set Point Accuracy

(This check applies only to units equipped with 3000 or CM3.5 Controllers.)

1. Insert a good-grade thermometer or pyrometer probe into the oil, with the end touching the fryer temperature-sensing probe.
2. When the 3000 controller displays “DROP” or the CM3.5 displays a product or dashed lines (indicating that the frypot contents are within the cooking range), press the  switch once to display the temperature and setpoint of the cooking oil as sensed by the temperature probe. The setpoint is the temperature with a dot after it.
3. Note the temperature on the thermometer or pyrometer. All three readings should be within $\pm 5^{\circ}\text{F}$ (2°C) of each other. If not, contact an Factory Authorized Servicer for assistance.

5.5 Annual/Periodic System Inspection

This appliance should be inspected and adjusted periodically by qualified service personnel as part of a regular kitchen maintenance program.

Frymaster recommends that this appliance be inspected at least annually by a Factory Authorized Servicer as follows:

5.5.1 Fryer

- Inspect the cabinet inside and out, front and rear for excess oil.
- Verify that the heating element wires are in good condition and that leads have no visible fraying or insulation damage and that they are free of oil.
- Verify that heating elements are in good condition with no carbon/caramelized oil build-up. Inspect the elements for signs of extensive dry-firing.
- Verify that the tilt mechanism is working properly when lifting and lowering elements, and that the element wires are not binding and/or chafing.

- Verify the heating-element amp-draw is within the allowed range as indicated on the appliance's rating plate.
- Verify that the temperature and high-limit probes are properly connected, tightened and functioning properly, and that mounting hardware and probe guards are present and properly installed.
- Verify that component box and contactor box components (i.e. controller/controller, relays, interface boards, transformers, contactors, etc.) are in good condition and free from oil and other debris.
- Verify that component box and contactor box wiring connections are tight and that wiring is in good condition.
- Verify that all safety features (i.e. contactor shields, drain safety switches, reset switches, etc.) are present and functioning properly.
- Verify that the frypot is in good condition and free of leaks and that the frypot insulation is in serviceable condition.
- Verify that all wiring harnesses and connections are tight and in good condition.

5.5.2 Built-In Filtration System

- Inspect all oil-return and drain lines for leaks and verify that all connections are tight.
- Inspect the filter pan for leaks and cleanliness. If there is a large accumulation of crumbs in the crumb basket, advise the owner/operator that the crumb basket should be emptied into a fireproof container and cleaned daily.
- Verify that all O-rings and seals (including those on the quick-disconnect fittings) are present and in good condition. Replace O-rings and seals if worn or damaged.
- Check filtration system integrity as follows:
 - Verify that filter pan cover is present and properly installed.
 - With the filter pan empty, place each filter handle, one at a time, in the ON position. Verify that the pump activates and that bubbles appear in the oil of the associated frypot.
 - Close all oil return valves (i.e., place all filter handles in the OFF position). Verify proper functioning of each oil return valve by activating the filter pump using the lever on one of the oil return handle microswitches. No air bubbles should be visible in any frypot.
 - Verify that the filter pan is properly prepared for filtering, then drain a frypot of oil heated to 350°F (177°C) into the filter pan and close the frypot drain valve. Place the filter handle in the ON position. Allow all oil to return to the frypot, indicated by bubbles in the oil. Return the filter handle to the OFF position. The frypot should have refilled in no more than 2 minutes and 30 seconds.

OCF30™ SERIES ELECTRIC FRYERS

CHAPTER 6: OPERATOR TROUBLESHOOTING

6.1 Introduction

This section provides an easy reference guide to some of the common problems that may occur during the operation of this equipment. The troubleshooting guides that follow are intended to help correct, or at least accurately diagnose, problems with this equipment. Although the chapter covers the most common problems reported, you may encounter problems that are not covered. In such instances, the Frymaster Technical Services staff will make every effort to help you identify and resolve the problem.

When troubleshooting a problem, always use a process of elimination starting with the simplest solution and working through to the most complex. Never overlook the obvious – anyone can forget to plug in a cord or fail to close a valve completely. Most importantly, always try to establish a clear idea of why a problem has occurred. Part of any corrective action involves taking steps to ensure that it doesn't happen again. If a controller malfunctions because of a poor connection, check all other connections, too. If a fuse continues to blow, find out why. Always keep in mind that failure of a small component may often be indicative of potential failure or incorrect functioning of a more important component or system.

Before calling a service agent or the Frymaster HOTLINE (1-800-24-FRYER):

- **Verify that electrical cords are plugged in and that circuit breakers are on.**
- **Verify that frypot drain valves are fully closed.**
- **Have your fryer's model and serial numbers ready to give to the technician assisting you.**

 **DANGER**

Hot oil will cause severe burns. Never attempt to move this appliance when filled with hot oil or to transfer hot oil from one container to another.

 **DANGER**

This equipment should be unplugged when servicing, except when electrical circuit tests are required. Use extreme care when performing such tests.

This appliance may have more than one electrical power supply connection point. Disconnect all power cords before servicing.

Inspection, testing, and repair of electrical components should be performed by an authorized service agent only.

6.2 Troubleshooting

6.2.1 Controller and Heating Problems

Problem	Probable Causes	Corrective Action
No Display on controller.	A. Controller not turned on. B. No power to the fryer. C. Failed controller or other component.	A. Press the ON/OFF switch to turn the controller on. B. Verify controller power cord is plugged in and that circuit breaker is not tripped. C. Call your FAS for assistance.
Controller displays IS VAT FULL? YES NO after a filtration.	A. Normal operation after a filtration. B. Oil may be in the filter pan.	A. Press ▲ (YES) if the vat is full, otherwise press ▼ (NO). B. Follow controller prompts to clear message. If problem persists, call your FAS for assistance.
Controller displays CHANGE FILTER PAPER?	Daily filter paper change prompt has occurred.	Press ▲ (YES), follow prompts and change the filter paper.
Fryer repeatedly cycles on and off when first started.	Fryer is in melt cycle.	This is normal operation. This will continue until the fryer temperature reaches 180°F (82°C).
Fryer does not heat.	A. Main power cord not plugged in. B. Drain is open. C. Controller has failed. D. One or more other components have failed.	A. Verify that all power cords are fully seated in the receptacles, locked into place and that a circuit breaker is not tripped B. Close drain. C. Call your FAS for assistance D. Call your FAS for assistance.
Fryer heats until high-limit trips with heat indicator ON.	Temperature probe or controller has failed.	Turn fryer off and call your FAS for assistance.
Fryer heats until high-limit trips without heat indicator ON.	Contact or controller has failed	Call your FAS for assistance.

6.2.2 Error Messages and Display Problems

Problem	Probable Causes	Corrective Action
Controller display is in wrong temperature scale (Fahrenheit or Celsius).	Incorrect display option programmed.	Fryers using the 3000 controller can toggle between F° to C° by pressing the ✓ button until Product setup is displayed. Press ► to scroll to Tech Mode and press ✓. Enter 1658. Press the scan button. The controller displays OFF . Turn the controller on to check temperature. If the desired scale is not displayed, repeat. Fryers using the CM3.5 should refer to the separate Fryer Controllers User's Manual.
Controller displays HEATING FAILURE.	Failed controller, failed interface board, open high-limit thermostat.	Turn the fryer off and on again. If issue persists call your FAS for assistance.

Problem	Probable Causes	Corrective Action
Controller displays <i>LO</i> or <i>LOW TEMP.</i>	Frypot temperature has dropped more than 21°F (12°C) for CM3.5 or 30°F (17°C) for 3000 controllers below setpoint in idle mode or 45°F (25°C) in cook mode.	This display is normal for a short while if a large batch of frozen product is added to the frypot or if the fryer is not heating properly. If the issue persists call your FAS for assistance.
Controller displays <i>HOT</i> or <i>HOT-HI-1.</i>	Frypot temperature is more than 410°F (210°C) or, in CE countries, 395°F (202°C).	Shut the fryer down immediately and call your FAS for assistance.
Controller displays <i>HI TEMP.</i>	Frypot temperature is more than 40 °F (4°C) above setpoint.	Press the power button to turn off fryer and let cool before returning power to fryer. If issue continues call your FAS for assistance.
CM III.5 displays <i>HI.</i>	Fryer is more than 21°F (12°C) above setpoint.	This display is normal if the fryer setpoint has been changed to a lower temperature. The display should revert to the normal four dashes when the frypot temperature cools to the setpoint. If the setpoint has not been changed, this indicates a problem with the temperature control circuitry. Turn the fryer off and call FAS.
Controller displays <i>HELP HI-2</i> or <i>HIGH LIMIT FAILURE.</i>	A. Open drain valve B. Failed high limit	A. Close the drain valve. B. Shut the fryer down immediately and call your FAS for assistance.
Controller displays <i>TEMP PROBE FAILURE</i> or <i>PROB.</i>	Problem with the temperature measuring circuitry including the probe or damaged controller wiring harness or connector.	Shut the fryer down and call your FAS for assistance.
Heating indicator is on, but fryer is not heating.	Three phase power cord unplugged or circuit breaker is tripped.	Verify that both the main power cord and 120V is fully seated in its receptacle, locked into place and that circuit breaker is not tripped. If the problem continues call your FAS for assistance.
Controller displays <i>RECOVERY FAULT/ YES</i> and alarm sounds.	Recovery time exceeded maximum time limit.	Clear error and silence the alarm by pressing the ▲ (YES) button. Maximum recovery time for electric is 1:40. If this error continues call your FAS for assistance.
Controller displays <i>SERVICE REQUIRED</i> followed by an error message.	An error has occurred which requires a service technician.	Press the ▲ (YES) button if the issue is fixed or press the ▼ (NO) button to continue cooking and call your FAS for assistance. In some cases, cooking may not be available.

6.2.3 Basket Lift Problems

PROBLEM	PROBABLE CAUSES	CORRECTIVE ACTION
Basket lift movement is jerky and/or noisy.	Basket lift rods need lubrication.	Apply a light coating of Lubriplate™ or similar lightweight white grease to the rod and bushings.

6.2.4 Filtration Problems

Problem	Probable Causes	Corrective Action
Fryer filters after each cook cycle.	Filter prompt setting incorrect.	Change the filter prompt setting.
Filter menu functions won't start.	Temperature too low.	Ensure fryer is at setpoint before starting; ensure the controller is ON.
Controller displays WAIT FOR FILTER.	Another function is still in process.	Wait until the previous function ends to start another filtration cycle.
Filter pump won't start or pump stops during filtering.	<ul style="list-style-type: none"> A. Power cord is not plugged in or circuit breaker is tripped. B. Pump motor has overheated causing the thermal overload switch to trip. C. Blockage in filter pump. 	<ul style="list-style-type: none"> A. Verify that the power cord is fully plugged in and the circuit breaker is not tripped. B. If the motor is too hot to touch for more than a few seconds, the thermal overload switch has probably tripped. Allow the motor to cool at least 45 minutes then press the Pump Reset Switch. (See page 5-4) C. Call your FAS for assistance.
Filter Pump runs, but oil return is very slow.	Improperly installed or prepared filter pan components or cold oil.	Remove the oil from the filter pan and replace the filter paper, ensuring that the filter screen is in place <i>under</i> the paper. Verify that O-rings are present and in good condition on filter pan connection fitting.
Controller displays OIL IN DRAIN PAN / CONFIRM	Drain valve open or possibility that oil is in drain pan.	Press ▲ (CONFIRM) and follow directions for FILL VAT FROM DRAIN PAN.

6.2.5 Auto Top-Off Problems

Problem	Probable Causes	Corrective Action
Frypots top off cold.	Incorrect setpoint.	Ensure setpoint is correct.
Frypots won't top off.	<ul style="list-style-type: none"> A. Fryer temperature too low. B. Oil is too cold. C. JIB out of oil D. Crumb build up around sensor E. Service required error exists 	<ul style="list-style-type: none"> A. Fryer temperature must be at setpoint. B. Ensure that the oil in the JIB is above 70°F (21°C). C. Ensure the JIB is not out of oil and supply line is in the JIB. Replace JIB and press the ▲ button when prompted to reset top off system. If problem persists call your FAS for assistance. D. Clean crumbs from opening surrounding sensor. E. Call your FAS for assistance.

Problem	Probable Causes	Corrective Action
Controller displays TOPOFF OIL EMPTY / CONFIRM	Top off system out of oil.	Fill top off system with oil and press the ▲ (CONFIRM) button.

6.2.6 Error Log Codes (For 3000 Controller Only)

Code	ERROR MESSAGE	EXPLANATION
E03	ERROR TEMP PROBE FAILURE	TEMP Probe reading out of range
E04	HI 2 BAD	High limit reading is out of range.
E05	HOT HI 1	High limit temperature is past more than 410°F (210°C), or in CE countries, 395°F (202°C)
E06	HEATING FAILURE	A component has failed in the high limit circuit such as controller, interface board, contactor or open-high limit.
E07	ERROR MIB SOFTWARE	Internal MIB software error
E08	ERROR ATO BOARD	ATO board connection lost; ATO board failure
E15	ERROR MIB BOARD	Cooking controller detects MIB connections lost; Check software version on each controller. If versions are missing, check CAN connections between each controller; MIB board failure
E17	ERROR ATO PROBE	ATO RTD reading out of range
E20	INVALID CODE LOCATION	SD card removed during update
E21	CHANGE FILTER PAPER	25 hour timer has expired. Change filter paper and follow prompts.
E22	OIL IN PAN ERROR	Oil may be present in the filter pan.
E25	RECOVERY FAULT	Recovery time exceeded maximum time limit. Recovery time should not exceed 1:40 for electric.
E27	LOW TEMP ALARM	Oil temperature has dropped 30°F (17°C) lower than setpoint in idle mode or 45°F (25°C) in cook mode. (This message may appear if a product is dropped and the start cook button is not pressed immediately or if too large of cook loads are dropped.)

6.2.7 HIGH-LIMIT TEST MODE

The high-limit test mode is used to test the high limit circuit. The high-limit test will destroy the oil. It should only be performed with old oil. Shut the fryer off and call for service immediately if the temperature reaches 460°F (238°C) without the high-limit tripping and the computer displays **HIGH LIMIT FAILURE** alternating with **DISCONNECT POWER** with an alert tone during testing.

The test is cancelled at any time by turning the fryer off. When the fryer is turned back on, it returns to the operating mode and displays the product.

1. Press and hold the check (✓) button until **MAIN MENU** is displayed followed by **PRODUCT SETUP**.

2. Press the left arrow (◀) button until **TECH MODE** is displayed.
3. Press the check (✓) button.
4. Enter 3000.
5. Press the left arrow (◀) button until **HI LIMIT TEST** is displayed.
6. Press the check (✓) button.

The controller displays **HIGH LIMIT YES/NO**.

7. Press the up arrow (▲) button.
8. The controller displays **PRESS AND HOLD CHECK**.
9. Press and hold the (✓) button to initiate the high-limit test.

The vat begins to heat. The computer displays the actual vat temperature during the test. The fryer continues heating until the high limit trips. Generally this happens once the temperature reaches 423°F to 447°F (217°C to 231°C) for non-CE high limits and 405°F to 426°F (207°C to 219°C) for CE high limits.

Once the high-limit opens the computer displays **HELP HI-2** alternating with the actual temperature (ex. **430F**).

10. Release the (✓) button.

If the high-limit fails, the computer displays **HIGH LIMIT FAILURE** alternating with **DISCONNECT POWER**. If this happens, disconnect power to the fryer and call for service immediately.

The vat stops heating and the computer displays the current temperature setting alternating with the actual temperature (ex. **430F**) until the temperature cools below 400°F (204°C).

11. Press the soft power button to cancel the alarm and go to **OFF**.
12. Follow the procedure to dispose of the oil.

OCF30™ SERIES ELECTRIC FRYER

APPENDIX A: JIB Preparation with Solid Shortening Option

1. Open right door of fryer and remove brace in JIB cabinet.
2. Position melter in front of cabinet. Loosen bracket on left side of melter, if necessary, to ease placement in the cabinet.
3. Use the provided screws to attach the melter to existing holes in the interior rails of the fryer cabinet on both sides. See figures 1 and 2.
4. Plug in the black connector to the outlet box shown in figure 3.*
5. Position the oil reservoir in the melter, sliding the oil pickup tube into the female receptacle. Position the front lid and the front of the melter. See figure 4.

***NOTE:** A separate harness with a white plug, if present, is **NOT** used.



Figure 1: Position the melter in the cabinet and attach with provided screws to the cabinet interior.



Figure 2: Position the melter.



Figure 3: Plug the **black** connector into the utility box as shown. A separate harness with a white plug, if present, is **NOT** used.



Figure 4: The assembled melter is shown in position.

Orange button resets system after a low oil display.

Melter ON/OFF switch.

Lift carefully to add shortening.

OCF30™ SERIES ELECTRIC FRYER

APPENDIX B: Solid Shortening Melter Use

Reset oil reservoir system

- Ensure shortening melter is on.
- Fill melter with shortening.
- Allow 2-3 hours for solid shortening to melt. **DO NOT** attempt to use the top off system with unmelted oil in the top off system. The low oil reservoir display will come on if the fryer calls for oil before the shortening in the melter is liquid.
- Once the shortening is fully melted, press and hold the orange reset button to reset the display and reset the top off system.
- **DO NOT ADD** hot oil to the shortening melter. The temperature of the oil reservoir should not exceed 140°F(60°C). Add small amounts of solid shortening to the reservoir to ensure it has sufficient oil to operate the top-off system.
- For best results, **DO NOT TURN OFF** the solid shortening melter overnight.
- The on/off switch for the melter is also used as a reset switch if the system's high limit temperature is reached.

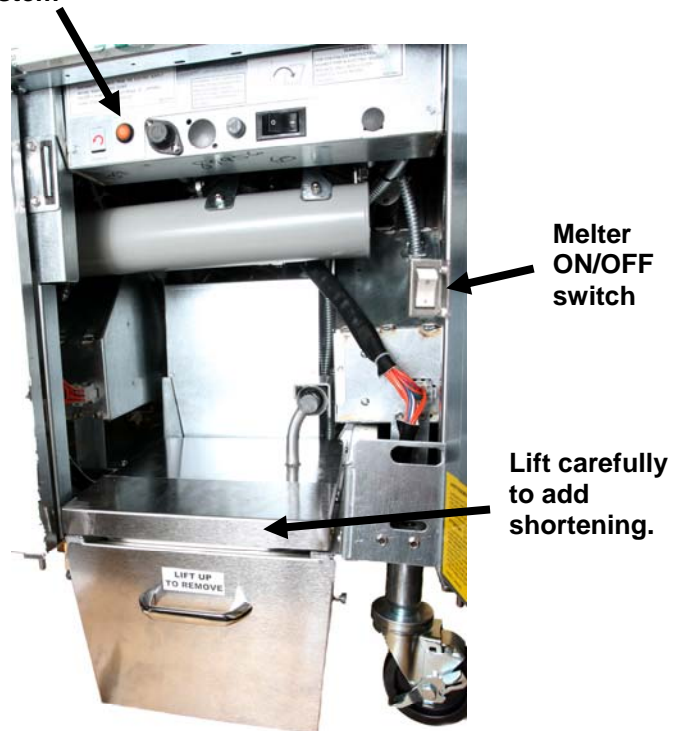

WARNING

The surfaces of the solid shortening heater are hot. Do not touch with bare hands. Wear protective clothing when adding shortening to melting unit.

OCF30™ SERIES ELECTRIC FRYER

APPENDIX C: BULK OIL INSTRUCTIONS

C.1.1 Bulk Oil Systems

Bulk oil systems have large oil storage tanks, typically located in the rear of the restaurant, that are connected to a rear manifold on the fryer. Some are waste only systems, while others are both waste and fresh oil. Waste oil is pumped from the fryer, via the fitting located on the bottom, to the disposal tanks and fresh oil is pumped from the tanks, thru the fitting located on the top, to the fryer (see Figure 1). The 4-pin wire harness allows connection to various bulk oil systems (see Figure 2). Connect pins 1 and 4 to the tank full switch to prevent overflow of the waste tank. Connect pins 2 and 3 to the fresh oil pump. Set the fryer to bulk through the vat setup mode on the far left controller. See 3000 controller manual section 1.4 on page 1-3. **It is imperative that the fryer system be completely power cycled after changing setup from JIB to Bulk.**

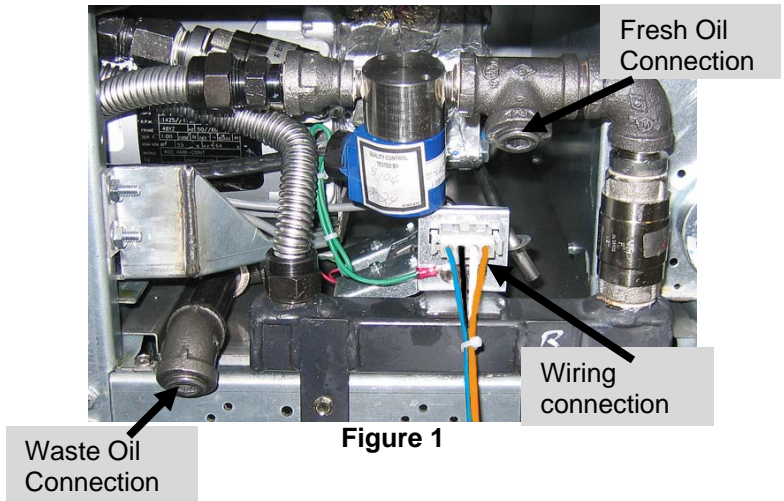

Figure 1

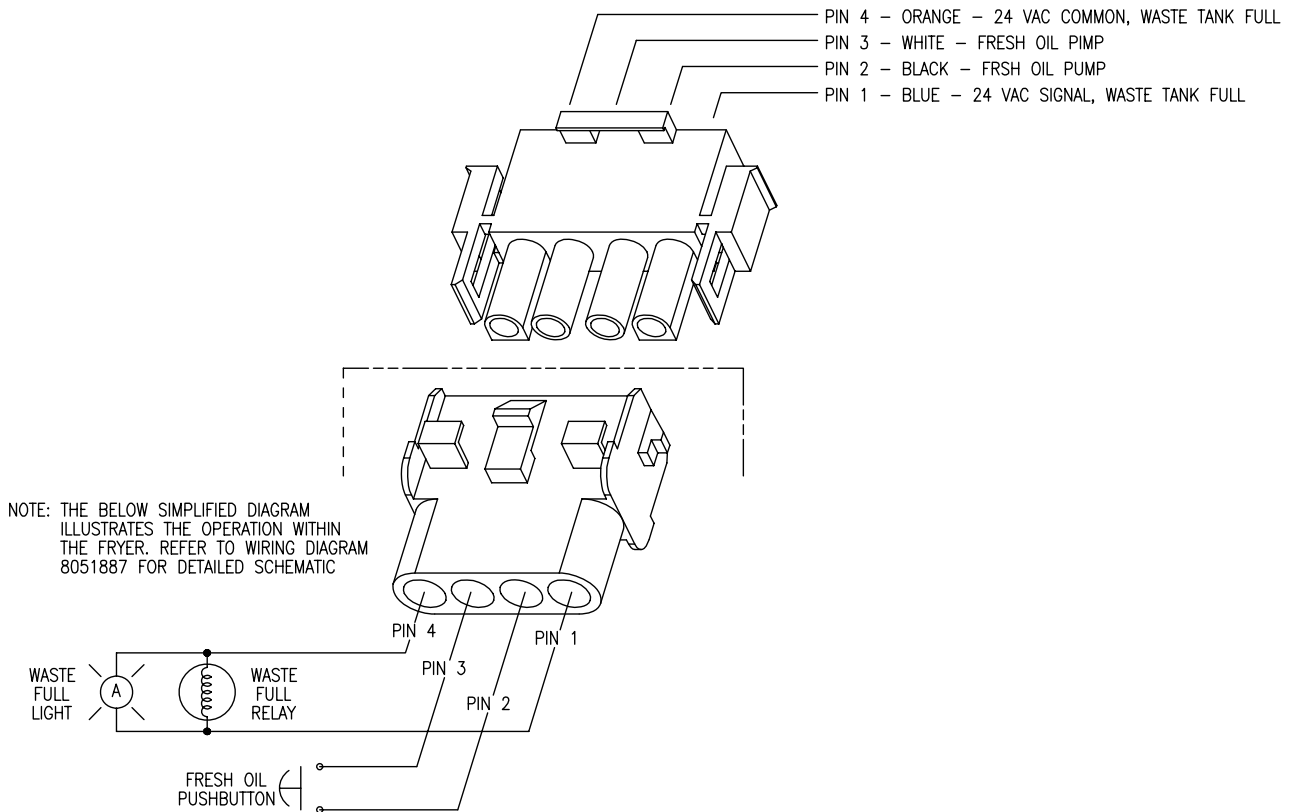

Figure 2

The OCF™ fryers, equipped for use with bulk oil systems, use an onboard fresh oil jug typically supplied by the bulk oil vendor. Remove the cap and insert the standard fitting into the jug with the metal cap resting on the lip of the jug. The oil is pumped in and out of the jug through the same fitting (see Figure 3).



Figure 3

⚠ WARNING
Do not add HOT or USED oil to a JIB

Operating the Bulk-Oil Equipped Fryer

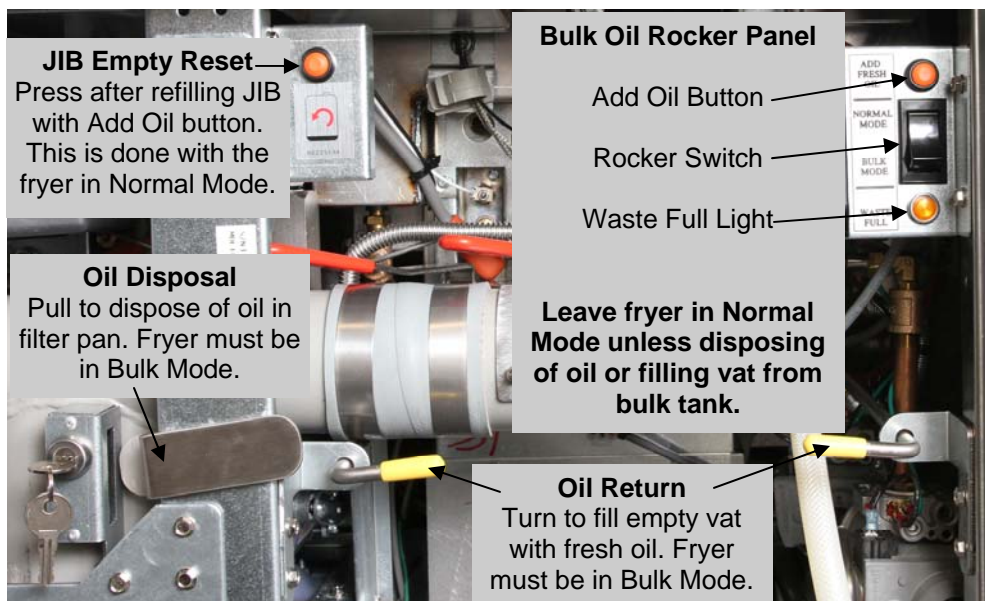

NOTE: The appearance of your fryer may differ slightly from that shown depending upon the configuration, fryer type and date of manufacture.

C.1.2 Filling the JIB

1. “TOPOFF OIL EMPTY” message appears on the controller.
2. Ensure the rocker switch is in Normal Mode.
3. Press and hold the orange button above rocker switch to fill the JIB.
4. Once the JIB is full, release the button.
5. Press orange JIB reset button to remove the Topoff Oil Empty message and return to normal operation.

* **NOTE:** It takes approximately 10 seconds from the time the button is pressed until the fresh oil pump starts. It may take up to 15 seconds before the level in the JIB begins to rise. It takes approximately four minutes to fill the JIB.

C.1.3 Dispose of Waste Oil

1. Ensure filter pan is prepared for filtration.
2. Drain vat into filter pan.
3. At rocker panel, switch to Bulk Mode.

4. Unlock dispose valve handle.
5. Pull the oil disposal valve and the pump will engage and empty the filter pan to the waste oil tank. The Waste Full light on the rocker panel will illuminate if the tank is full.
6. Filling with fresh oil? See Fill Vat from Bulk below. If not, switch to Normal Mode at rocker panel

C.1.4 Fill Vat from Bulk Tank

1. Ensure vat is empty and the drain valve is closed.
2. At the rocker panel, switch to Bulk Mode.
3. Open the return valve on the empty tank. Press the Add Fresh Oil button. Fill to the lower line in the frypot.
4. Close the return valve.
5. Ensure the filter pan is empty.
6. At the rocker panel, switch to Normal Mode.

* **NOTE:** It takes approximately fifteen seconds from the time the Add Fresh Oil button is pressed until the bulk fresh oil pump starts. It may take up to 25 seconds before the level in the vat begins to rise. It takes approximately one minute to fill a split vat and two minutes to fill a full vat.

THIS PAGE INTENTIONALLY LEFT BLANK



Frymaster, L.L.C., 8700 Line Avenue, Shreveport, Louisiana 71106

TEL 1-318-865-1711

(Tech Support Fax) 1-318-219-7135

PRINTED IN THE UNITED STATES

SERVICE HOTLINE
1-800-551-8633

8196685
05/2016